

96-1 Parallel Output Assembly  
IG2000PS120GA-13400

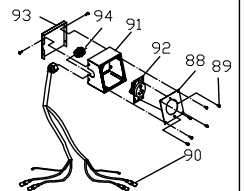

96 Parallel Output Assembly  
IG2000PS120JA-13400



7 Fuel Tank Cover  
KGE2000Ti-b-07200



80 Fuel Tank  
KGE2000Ti-b-07500

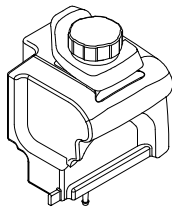

37 Control Panel Assembly  
IG2000/S1A-13100

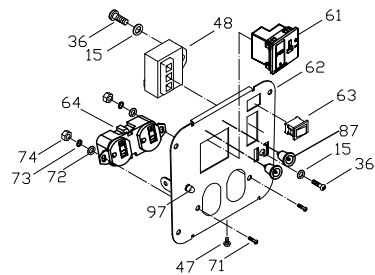

13 Alternator Assembly  
KD (M) 20 (A) -02000

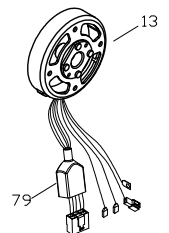

Ref.No	Kipor No.	NTP No.	Description	Qty.
1	KG158-b-00000	48-0778	KG158 Gasoline Engine Assembly	1
2	KGE3000TI-03008		Insert M5	8
3	KGE2000TI-A-03300	48-0823	Right Cover & Insert	1
4	GB/T97.1-2002		Back Up Ring 6	4
5	GB/T818-2000		Cross Recessed Pan Head Screw M6X20	3
6	KGE2000TI-03600	48-0841	Spark Plug Maintenance Door	1
7	KGE2000TI-b-07200	48-0825	Fuel Cap	1
8	KGE2000TI-07005	48-0821	Fuel Fill cover	1
9	KGE2000TI-03002		Hexagon Head Recessed Bolt M6X180	2
10	GB/T818-2000		Cross Recessed Pan Head Screw M5X25	2
11	KGE1000TI-06301		Right Engine Cover Crossed Protection Rack	1
12	KGE2000TI-03003		Hexagon Head Recessed Bolt M6X70	1
13	KDM20A-02000	48-0770	Alternator Assembly	1
14	GB/T818-2000		Cross Recessed Pan Head Screw M5X16	8
15	GB/T97.1-2002		Back Up Ring 5	5
16	KGE2000TI-03009	48-0817	Front Cover	1
17	DU20(120V/60HZ)-C	48-0732	Inverter	1
18	KGE1000TI-00008		Module Shock Absorbing Pad	2
19	KGE1000TI-00004		Rubber Square Protection Rack	1
20	KGE2000TI-03200		Rear Cover & Insert	1
21	KGE1000TI-b-07011	48-0813	Filter Bow	1
22	KGE2000TI-b-07001	48-0825	Fuel Tank	1
23	KGE1000TI-07004	48-0828	Vent Hose	1
24	KGE1000TI-07012		Clamp φ10	1
25	KGE1000TI-b-07001	48-0809	Fuel Pipe I (Fuel Tank-Fuel Switch)	1
26	KGE1000TI-07006		Clamp φ7	3
27	KGE1000TI-07300	48-0806	Fuel Switch Assembly	1
28	KGE2000TI-b-07002	48-0826	Fuel Pipe II (Fuel Switch-Vacuum Pump)	1
29	KGE2000TI-12102a		Hollow Shaft	2
30	KGE3000TI-03017		Micro Switch Baffle Plate	1
31	KGE2000TI-b-12110a		Engine Fixture Plate	1
32	KW4A-Z6CSF200	48-0902	Micro Switch	1
33	KGE2000TI-04300		Bottom Airway Baffle Plate	1
34	KGE2000TI-b-07003	48-0827	Fuel Pipe III(Vacuum Pump-Carburetor)	1
35	GB/T845-1985		Self-Tapping Screw ST3.8X16	6
36	GB/T818-2000		Cross Recessed Pan Head Screw M5X12	2
37	IG2000/S1A-13100		Control Panel Assembly	1
38	GB/T5789-1986		Hexagon Flange Bolt M8X30	4
39	KGE2000TI-12101b		Shock Absorbing Pad	4
40	KD20(A)-02200		Rotor Assembly	1
41	KD20(A)-02100		Stator Assembly	1
42	KGE2000TI-03004	48-0816	Rubber Foot	4
43	GB/T5789-1986		Hexagon Flange Bolt M6X12	7
44	KGE1000TI-07008		Fuel Switch Handle	1
45	KGE1000TI-07304		Screw	1
46	KGE1000TI-06102		Handle Fixture Mount	1
47	GB/T818-2000		Cross Recessed Pan Head Screw M5X10	2
48	KI-DHQ-20	48-0899	Ignition Module- IG2000	1
49	KGE2000TI-04200		Inlet Side Baffle Plate	1
50	KGE1000TI-00006	48-0791	Service Door Screw M5*12	1
51	KGE2000TI-03500	48-0819	Side Door	1
52	KGE2000TI-A-03400	48-0824	Left Engine Cover & Insert	1
53	KGE2000TI-03001		Rear Cover Seal	1
54	KGE1000TI-06101		Left Engine Cover Cross Protection Rack	1
55	KGE1000TI-07100	48-0804	Fuel Vacuum Pump	1
56	GB/T896-1986		Retaining Ring 9	1
57	KGE2000TI-04100		Exhaust Side Buffer Plate	1
58	KGE1000TI-b-07013		Fuel Indicator	1
59	GB/T818-2000		Cross Recessed Pan Head Screw M5X20	1
60	KBPC2510	48-0769	Rectifier	1
61	WZ-Z2-a	48-0911	DC Receptacle	1
62	IG2000/S1A-13110		Control Panel Stamping	1
63	RF-1003-BB2	48-0908	Rocker Switch	1
64	5-20R	48-0726	Duplex Receptacle	1
65	KGE2000TI-13601	48-0822	Trigger	1
66	KGE2000TI-13340		Rectifier Support	1
67	GB/T96.1-2002		Large Back Up Ring 6	2
68	KGE1000TI-07007		Clamp φ9	3
69	KGE2000TI-04400		Alternator Wire Outlet Seal Pad	1
70	GB/T5789-1986		Hexagon Flange Bolt M5X12	2
71	GB/T818-2000		Cross Recessed Pan Head Screw M4X16	2
72	GB/T97.1-2002		Back Up Ring 4	4
73	GB/T93-1987		Elastic Back Up Ring 4	2
74	GB/T41-2000		Hexagon Nut M4	2
75	GB/T93-1987		Elastic Back Up Ring 6	3
76	GB/T845-1985		Screw ST2.9X12	1
77	GB/T70.1-2000		Inner Hexagon Screw M5X30	2
78	GB/T862.2-1987		Back Up Ring With External Tooth 6	1
79	KGE1000TI-13301		Electrical Protection Shell	1
80	KGE2000TI-b-07500		Fuel Tank	1
81	KGE2000TI-b-07004	48-0828	Ventilation Hose	1
82	KGE2000TI-b-07009		Ventilation Hose Seal Sheath	1
83	KGE2000TI-b-07006	48-0829	Fuel Tank Ventilation Hose	1
84	KGE2000TI-b-07400	48-0833	Carbon Canister	1
85	KGE2000TI-b-07008	48-0831	Carbon Canister Sub Pressure Hose	1
86	KGE2000TI-b-07007	48-0830	Air Bend Hose	1
87	KT5A62		Parallel Output Socket	1
88	IG2000PS120JA-13404		Receptacle Output Board	1
89	GB/T818-2000		Screw M4x10	10
90	KT5ABD70	48-0901	Repl Power Cable	2
91	IG2000P-13402		Receptacle Cover	1
92	1263		Receptacle 30A/125V	1
93	IG2000P-13401	48-0739	Rear Cover	1
94	IG2000P-13403		Plastic Protection Ring (Diameter=35)	1
95	IG2000PS120JA-13400		Parallel Output Assembly	1
96	IG2000PS120JA-13401		Parallel Output Assembly	1
97	PE74	48-0906	Overload Restart Switch	1

# KG158 (CARB)

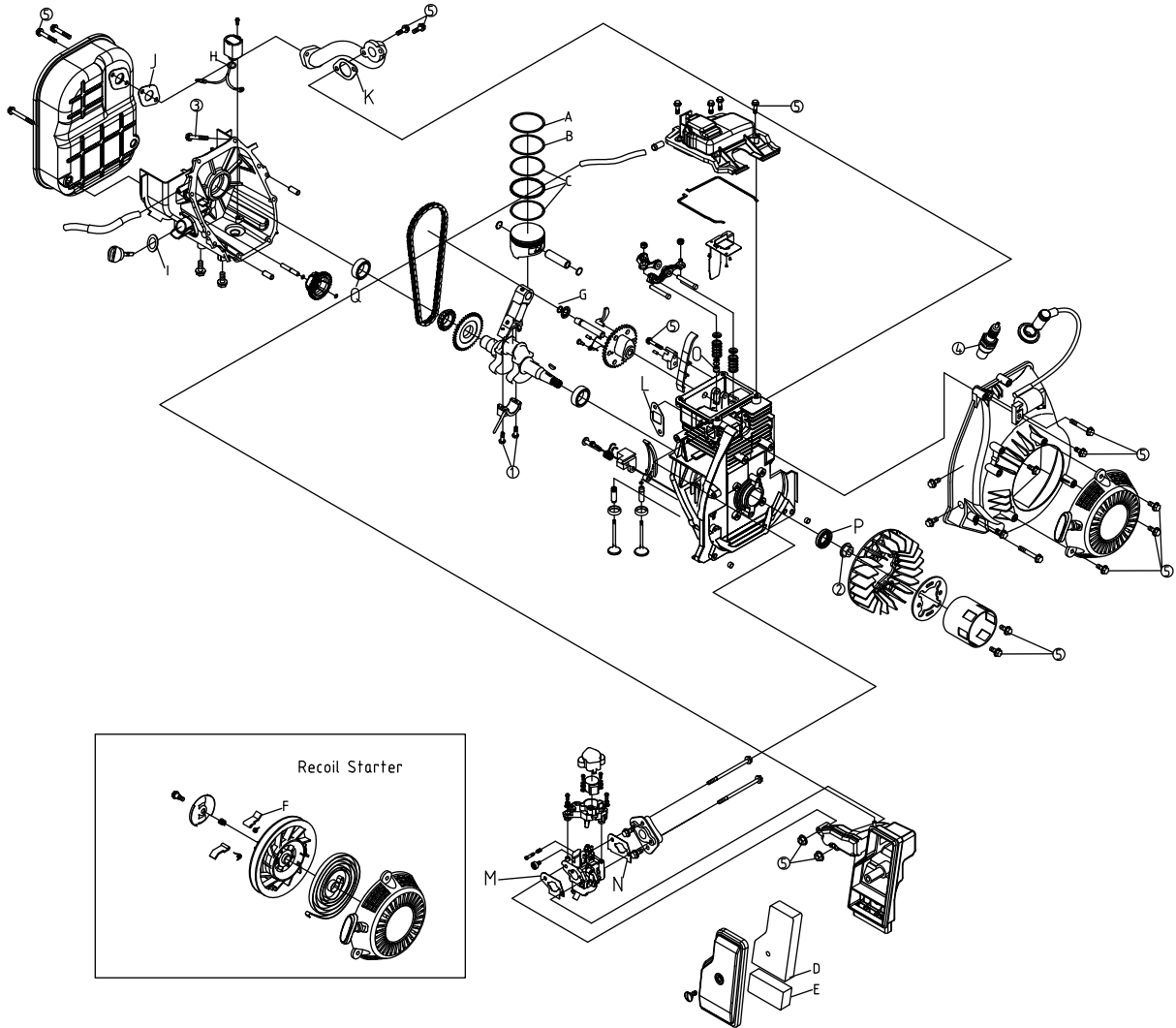

## Easy Wearing Parts

Ref	P/N	Description	Qty
A	KG105-04001	1st Compression Ring	1
B	KG105-04002	2nd Compression Ring	1
C	KG105-04100	Oil Ring	1
D	KG105-07003	Fine Filter Element	1
E	KG105-07004	Rough Filter Element	1
F	KG160-12008	Claw	2

## Gasket

Ref	P/N	Description	Qty
I	KG240-01016	Oil Level Gauge Gasket	1
J	KG105-08002	Muffler Gasket	1
K	KG105-01021	Exhaust Pipe Gasket	1
L	KG105-01018	Intake Pipe Gasket	1
M	KG55-10003	Carburetor Gasket	1
N	KG55-10004	Carburetor Gasket A	1

## Bearing

Ref	P/N	Description	Qty
Q	GB/T276-1994	Deep groove ball bearing6204	2

Tightening Torque Table For Major Bolt and Nut  
(Unit: N.M)

Ref	Description	Torque
①	Connecting Rod Bolt	8-10
②	Flywheel Nut	70-80
③	Crankcase Cover Bolt	8-10
④	Spark Plug	12-14
⑤	Standard M6 Bolt (Nut)	8-10

## O-Seal Ring

Ref	P/N	Description	Qty
G	KG105-06014	O-Seal Ring(6x2)	1
H	KG105-14201	O-Seal Ring (11.7x2.5)	1

## Oil Seal

Ref	P/N	Description	Qty
O	KG105-01022	Intake Valve Guiding Pipe Oil Seal	1
P	KG105-01004	Oil Seal	1

**Consumable Parts**

REF	Kipor No.	NTP No.	Description	Qty
A	KG105-04001		1st Compression Ring	1
B	KG105-04002		2nd Compression Ring	1
C	KG105-04100		Oil Ring	1
D	KG105-07003	48-0985	Fine Filter Element	1
E	KG105-07004	48-0986	Rough Filter Element	1
F	KG160-121008		Starter Claw	2

**O Ring**

G	KG105-06014		O ring 6x2	1
H	KG105-14201		O ring 11.7x2.5	1

**Gasket**

I	KG240-01016	48-0950	Oil Level Gauge Gasket	1
J	KG105-08002	48-0914	Muffler Gasket	1
K	KG105-01021	48-0913	Exhaust Pipe Gasket	1
L	KG105-01018		Intake Gasket	1
M	KG55-10003	48-0972	Carburetor Gasket	1
N	KG55-10004	48-0973	Carburetor Gasket A	1

**Oil Seal**

O	KG105-01022		Intake Valve Guide Oil Seal	1
P	KG105-01004		Oil Seal	1

**Bearing**

Q	GB/T276-1994		Roller Bearing 6204	1
---	--------------	--	---------------------	---

**Tightening Torque Table**

Ref	Description	Torque (NM)
1	Connecting Rod Bolt	8-10
2	Flywheel Nut	70-80
3	Crankcase Cover Bolt	8-10
4	Spark Plug	12-14
5	Standard M6 Bolt	8-10

### Engine Block (KG105AGTi-01000)

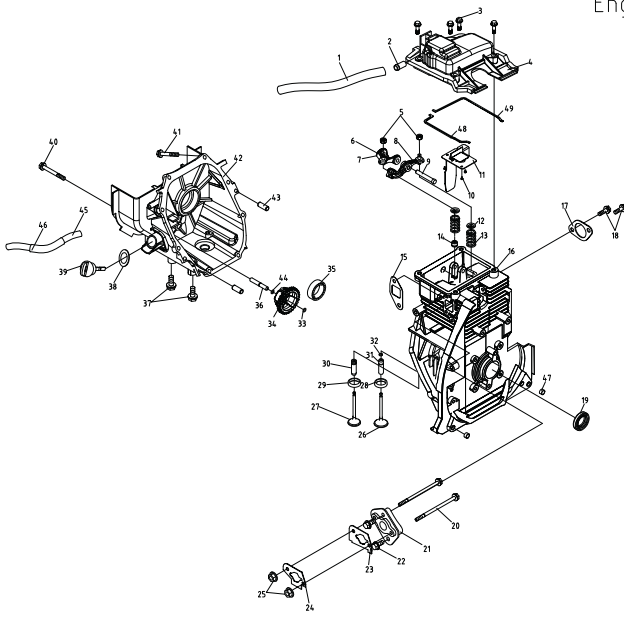

Ref	P/N	Description	Qty
1	KG105AGTi-01036	Vent Pipe	1
2	KG105AGTi-01025	Coupling	1
3	GB/T5789-1986	Hexagon Head Bolt M6X25	4
4	KG105AGTi-01011	Cylinder Head Cover	1
5	KG105-01005	Adjusting Nut, Valve Clearance	2
6	KG105-01006	Adjusting Screw, Valve Clearance	2
7	KG105AGTi-01401	Intake Valve Rocker Arm	1
8	KG105AGTi-01501	Exhaust Valve Rocker Arm	1
9	KG105AGTi-01007	Rocker Shaft	1
10	GB/T818-2000	Screw M3X5	3
11	KG105AGTi-01200	Respirator Cover Plate (1) Weldment	1
12	KG55-01026	Valve Spring Seat	2
13	KG105-01027	Valve Spring	2
14	KG105-01022	Intake Valve Guiding Pipe Oil Seal	1
15	KG105-01018	Intake Pipe Gasket	1
16	KG105AGTi-01101	Engine Block	1
17	KG105-01021	Exhaust Pipe Gasket	1
18	GB/T5789-1986	Hexagon Head Bolt M6X20	2
19	KG105-01004	Oil Seal (Φ32XΦ20X6)	1
20	KG105-01019	Carburetor Bolt	2
21	KG105-01017	Carburetor Insulation Block	1
22	GB/T16674.1-2004	Bolt M6X25	2
23	KG55-10004	Carburetor Gasket A	1
24	KG55-10003	Carburetor Gasket	1
25	GB/T6177.1-2000	Nut M5	2

Ref	P/N	Description	Qty
26	KG105-01024	Exhaust Valve	1
27	KG105-01023	Intake Valve	1
28	KG105-01105	Exhaust Valve Seat	1
29	KG105-01104	Intake Valve Seat	1
30	KG105-01102	Intake Valve Guiding Pipe	1
31	KG105-01103	Exhaust Valve Guiding Pipe	1
32	KG160-02104	Exhaust Valve Guiding Pipe External Retaining Ring	1
33	KG160-11009	Retaining Ring	1
34	KG105AGTi-01038	Oil-Leakage Gear	1
35	GB/T276-1994	Rolling Bearing 6204	1
36	KG105-01039a	Oil-Leakage Gear Shaft	1
37	GB/T5789-1986	Hexagon Head Bolt M8X30	4
38	KG240-01016	Oil Level Gauge Gasket	1
39	KG55-01031	Oil Level Gauge	1
40	GB/T5789-1986	Hexagon Head Bolt M6X80	1
41	GB/T5789-1986	Hexagon Head Bolt M6X25	8
42	KG105AGTi-01001	Crankcase Cover	1
43	KG105-01003a	Crankcase Cover Location Pin	2
44	KG160-11013	Speed Limit Gear Gasket	1
45	KG105AGTi-01034	Negative Pressure Pipe	1
46	KG105-01035	Pipe Sleeve	1
47	KG105-01041	Cushion	2
48	KG105-01014	Seal Gasket (I)	1
49	KG105-01015	Seal Gasket (II)	1

### Piston & Connecting Rod Assembly (KG105-04000)

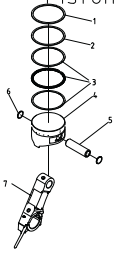

Ref	P/N	Description	Qty
1	KG105-04001	1st Compression Ring	1
2	KG105-04002	2nd Compression Ring	1
3	KG105-04100	Oil Ring	1
4	KG105-04003	Piston	1
5	KG135L-04004	Piston Pin	1
6	KG135L-04005	Retaining Ring	2
7	KG105-04200	Connecting Rod	1

### Crankshaft & Flywheel Assembly (KG105-05000)

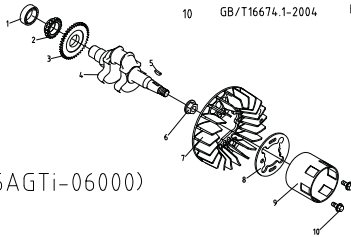

Ref	P/N	Description	Qty
1	GB/T276-1994	Rolling Bearing 6204	1
2	KG105-05002	Crankshaft Timing Link Wheel	1
3	KG105-05003	Driving Gear	1
4	KG105-05001	Crankshaft	1
5	KG55-05003	Key 3X4.9X16	1
6	KG105-05008	Flywheel Nut	1
7	KG105-05005	Fan Wheel	1
8	KG105-05006	Fan Wheel Pressing Plate	1
9	KG105-05007b	Starting Claw Disk	1
10	GB/T16674.1-2004	Bolt M6X12	2

### Carburetor Assembly (KG105-b-10000)

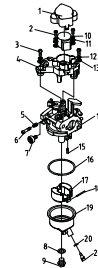

Ref	P/N	Description	Qty
1	KG55-10002	Motor Bracket Cover	1
2	GB/T818-2000	Screw M3X5	2
3	GB/T818-2000	Screw M4X10	2
4	KG55-10001	Motor Bracket	1
5	P15-021	Adjusting Spring	1
6	P15-009	Mixed Ratio Adjusting Screw	1
7	P15-014	Idle Set Screw	1
8	P15-010	Seal Sleeve	1
9	P15-034	Oil Cup Fastening Screw	1
10	GB/T93-1987	Spring Back Up Ring	2
11	GB/T848-1985	Back Up Ring	2
12	GB/T93-1987	Spring Back Up Ring	2
13	GB/T848-1985	Back Up Ring	2
14	P15-b-000	Carburetor	1
15	P15-012	Oil Control Needle	1
16	P15-004	Oil Cup Seal Ring	1
17	P15-002	Floater	1
18	P15-011	Pin, Float	1
19	P15-006	Oil Cup	1
20	P15-024	Seal Ring	1
21	P15-025	Oil Drain Screw	1

### Valve & Pressure Reducing Mechanism (KG105AGTi-06000)

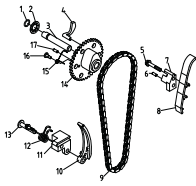

Ref	P/N	Description	Qty
1	KG105AGTi-06014	O-Seal Ring(6x2)	1
2	KG105AGTi-06103	Diaphragm Spring	1
3	KG105AGTi-06013	Driving Shaft	1
4	KG105AGTi-06102	Decompression Flyweight	1
5	GB/T770.1-2000	Screw M6x25	2
6	GB/T119.2-2000	Pin 6x15	1
7	KG105-06012	Fixture Block	1
8	KG105-06003	Chain Supporting Plate	1
9	KG105-06002	Roller Chain	1
10	KG105-06001	Chain Plate	1
11	KG105-06011	Block	1
12	KG105-06008a	Tension Spring	1
13	KG105-06009	Tension Spring Pin Shaft	1
14	KG105AGTi-06101	Cam Timing Driving Link Wheel	1
15	KG105-06006	Return Spring	1
16	KG105-06007	Return Spring Pin Shaft	1
17	GB/T879.1-2000	Pin 3x12	1

### Ignition System (KG105AGTi -14000)

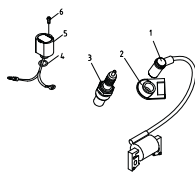

Ref	P/N	Description	Qty
1	KG105-14100	Ignition Coil	1
2	KG105AGTi-14101	Seal Sleeve	1
3	BOSCH R6 UR5 SUF	Spark Plug	1
4	KG105-14201	O-Seal Ring (11.7x2.5)	1
5	KG105-14200	Oil Alert	1
6	GB/T5789-1986	Bolt M6X14	1

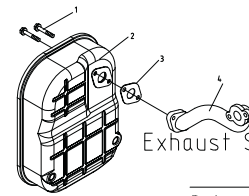

### Exhaust System (KG105-b-08000)

Ref	P/N	Description	Qty
1	GB/T5789-1986	Bolt M6X70	2
2	KG105-b-08100c	Muffler Weldment	1
3	KG105-08002	Muffler Gasket	1
4	KG105-b-08001	Exhaust Pipe	1

### Air-Intake System (KG105AGTi-b-07000)

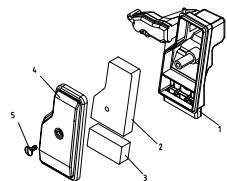

Ref	P/N	Description	Qty
1	KG105AGTi-b-07100	Air Filter Shell	1
2	KG105-07003	Fine Filter Element	1
3	KG105-07004	Rough Filter Element	1
4	KG105-07001	Air Filter Cover	1
5	KG105-07002	Fastening Screw	1

### Recoil Starter & Wind Scooper Assembly (KG105-12000)

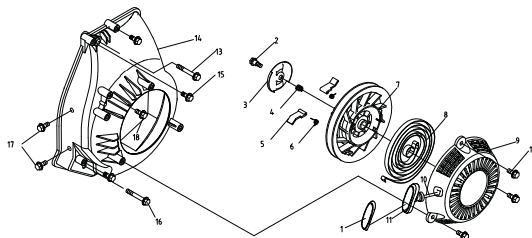

Ref	P/N	Description	Qty
1	KG160-12202	Starter Handle Cover	1
2	KG240-12006	Fastening bolt	1
3	KG240-12005	Claw Guiding Plate	1
4	KG240-12004	Friction Spring	1
5	KG240-12008	Claw	2
6	KG240-12007	Claw Spring	2
7	KG105-12203	Starter Winding Shaft	1
8	KG160-12003	Recoil Starter Spring	1
9	KG105-12210	Starter Shell	1
10	KG160-12009	Starting String	1
11	KG105-12201	Starting Handle	1
12	GB/T5789-1986	Bolt M6X16	3
13	GB/T5789-1986	Bolt M6X40	1
14	KG105-12100	Wind Scooper	1
15	GB/T5789-1986	Bolt M6X20	2
16	GB/T5789-1986	Bolt M6X50	2
17	GB/T5789-1986	Bolt M5X10	1
18	GB/T5789-1986	Bolt M6X10	1

NO	Kipor Number	NTP No.	Description	Qty.
	<b>(KG105AGTI-01000)</b>		<b>Engine block Assembly</b>	
1	KG105AGTi-01036	48-0919	Vent Pipe	1
2	KG105AGTi-01025		Coupling	1
3	GB/T5789-1986		Hexagon Head BoltM6X25	4
4	KG105AGTi-01011	48-0917	Valve Cover	1
5	KG105-01005		Adjusting Nut, Valve Clearance	2
6	KG105-01006		Adjusting Screw, Valve Clearance	2
7	KG105AGTi-01401		Intake Valve Rocker Arm	1
8	KG105AGTi-01501		Exhaust Valve Rocker Arm	1
9	KG105AGTi-01007		Rocker Shaft	1
10	GB/T818-2000		Screw M3X5	3
11	KG105AGTi-01200		Respirator Cover Plate ( I ) Weldment	1
12	KG55-01026		Valve Spring Seat	2
13	KG105-01027		Valve Spring	2
14	KG105-01022		Intake Valve Guiding Pipe Oil Seal	1
15	KG105-01018		Intake Pipe Gasket	1
16	KG105AGTi-01101		Engine Block	1
17	KG105-01021		Exhaust Pipe Gasket	1
18	GB/T5789-1986		Hexagon Head Bolt M6X20	2
19	KG105-01004		Oil Seal (Φ32×Φ20×6)	1
20	KG105-01019		Carburetor Bolt	2
21	KG105-01017	48-0912	Carburetor Insulation Block	1
22	GB/T16674.1-2004		Bolt M6X25	2
23	KG55-10004	48-0973	Carburetor Gasket A	1
24	KG55-10003	48-0972	Carburetor Gasket	1
25	GB/T6177.1-2000		Nut M5	2
26	KG105-01024		Exhaust Valve	1
27	KG105-01023		Intake Valve	1
28	KG105-01105		Exhaust Valve Seat	1
29	KG105-01104		Intake Valve Seat	1
30	KG105-01102		Intake Valve Guiding Pipe	1
31	KG105-01103		Exhaust Valve Guiding Pipe	1
32	KG160-02104		Exhaust Valve Guiding Pipe External Retainning Ring	1
33	KG160-11009		Retaining Ring	1
34	KG105AGTi-01038		Oil-Leakage Gear	1
35	GB/T276-1994		Rolling Bearing 6204	1
36	KG105-01039a		Oil-Leakage Gear Shaft	1
37	GB/T5789-1986		Hexagon Head Bolt M8X30	4
38	KG240-01016	48-0950	Oil Level Gauge Gasket	1
39	KG55-01031	48-0969	Oil Level Gauge	1
40	GB/T5789-1986		Hexagon Head Bolt M6X80	1
41	GB/T5789-1986		Hexagon Head Bolt M6X25	8
42	KG105AGTi-01001		Crankcase Cover	1
43	KG105-01003a		Crankcase Cover Location Pin	2
44	KG160-11013		Speed Limit Gear Gasket	1

45	KG105AGTi-01034	48-0918	Breather Hose	1
46	KG105-01035		Pipe Sleeve	1
47	KG105-01041		Cushion	2
48	KG105-01014		Seal Gasket ( I )	1
49	KG105-01015		Seal Gasket ( II )	1
	<b>(KG105-04000)</b>		<b>Piston connecting assembly</b>	
1	KG105-04001		1st Compression Ring	1
2	KG105-04002		2nd Compression Ring	1
3	KG105-04100		Oil Ring	1
4	KG105-04003		Piston	1
5	KG135L-04004		Piston Pin	1
6	KG135L-04005		Retainning Ring	2
7	KG105-04200		Connecting Rod	1
	<b>KG105AGTi-06000</b>		<b>Valve &amp; Pressure Reducing Mechanism</b>	
1	KG105AGTi-06014		O-Seal Ring(6*2)	1
2	KG105AGTi-06103		Diaphragm Spring	1
3	KG105AGTi-06013		Driving Shaft	1
4	KG105AGTi-06102		Decompression Flyweight	1
5	GB/T70.1-2000		Screw M6x25	2
6	GB/T119.2-2000		Pin 6x15	1
7	KG105-06012		Fixture Block	1
8	KG105-06003		Chain Supporting Plate	1
9	KG105-06002		Roller Chain	1
10	KG105-06001		Chain Plate	1
11	KG105-06011		Block	1
12	KG105-06008a		Tension Spring	1
13	KG105-06009		Tension Spring Pin Shaft	1
14	KG105AGTi-06101		Cam Timing Driving Link Wheel	1
15	KG105-06006		Return Spring	1
16	KG105-06007		Return Spring Pin Shaft	1
17	GB/T879.1-2000		Pin 3x12	1
	<b>KG105-05000</b>		<b>Crankshaft &amp; Flywheel Assembly</b>	
1	GB/T276-1994		Rolling Bearing 6204	1
2	KG105-05002		Crankshaft Timing Link Wheel	1
3	KG105-05003		Driving Gear	1
4	KG105-05001		Crankshaft	1
5	KG55-05003		Key 3×4.9×16	1
6	KG105-05008		Flywheel Nut	1
7	KG105-05005		Fan Wheel	1
8	KG105-05006		Fan Wheel Pressing Plate	1
9	KG105-05007b		Starting Claw Disk	1
10	GB/T16674.1-2004		Bolt M6×12	2

	<b>KG105-b-10000</b>		<b>Carburetor Assembly</b>	
1	KG55-10002		Motor Bracket Cover	1
2	GB/T818-2000		Screw M3X5	2
3	GB/T818-2000		Screw M4X10	2
4	KG55-10001		Motor Bracket	1
5	P15-021		Adjusting Spring	1
6	P15-009		Mixed Ratio Adjusting Screw	1
7	P15-014		Idle Set Screw	1
8	P15-010		Seal Sleeve	1
9	P15-034		Oil Cup Fastening Screw	1
10	GB/T93-1987		Spring Back Up Ring3	2
11	GB/T848-1985		Back Up Ring 3	2
12	GB/T93-1987		Spring Back Up Ring4	2
13	GB/T848-1985		Back Up Ring 4	2
14	P151-b-000	48-0982	Carburetor	1
14a	P151-015A	48-0992	High Altitude Jet	
14b	24BYJ24D	48-0723	Stepping Motor	
15	P15-012		Oil Control Needle	1
16	P15-004		Oil Cup Seal Ring	1
17	P15-002		Floater	1
18	P15-011		Pin, Float	1
19	P15-006		Oil Cup	1
20	P15-024		Seal Ring	1
21	P15-025		Fuel Drain Screw	1
	<b>KG105-b-08000</b>		<b>Exhaust System</b>	
1	GB/T5789-1986		Bolt M6X70	2
2	KG105-b-08100c	48-0921	Muffler Assembly	1
3	KG105-08002	48-0914	Muffler Gasket	1
4	KG105-b-08001	48-0920	Exhaust Pipe	1
5				
6				
7				
8				
9				
<b>点火系统 (KG105AGTi-14000)</b>				
1	KG105-14100	48-0915	Ignition Coil	1
2	KG105AGTi-14101		Seal Sleeve	1
3	UR5	48-0997	Spark Plug	1
4	KG105-14201		O-Seal Ring (11.7*2.5)	1
5	KG105-14200	48-0916	Oil Alert	1
6	GB/T5789-1986		Bolt M6X14	1
<b>反冲起动机及导风罩总成 (KG105-12000)</b>				



1	KG160-12202		Starter Handle Cover	1
2	KG240-12006		Fastening bolt	1
3	KG240-12005		Claw Guiding Plate	1
4	KG240-12004		Friction Spring	1
5	KG240-12008		Claw	2
6	KG240-12007		Claw Spring	2
7	KG105-12203		Starter Winding Shaft	1
8	KG160-12003		Recoil Starter Spring	1
9	KG105-12210		Starter Shell	1
10	KG160-12009		Starting String	1
11	KG105-12201		Starting Handle	1
12	GB/T5789-1986		Bolt M6X16	3
13	GB/T5789-1986		Bolt M6X40	1
14	KG105-12100		Fan	1
15	GB/T5789-1986		Bolt M6X20	2
16	GB/T5789-1986		Bolt M6X50	2
17	GB/T5789-1986		Bolt M5X10	1
18	GB/T5789-1986		Bolt M6X10	1
19	KG55-12000	48-0974	Recoil Starter Assembly	1
19				
<b>进气系统(KG105AGTi-b-07000)</b>				
1	KG105AGTi-b-07100		Air Filter Shell	1
2	KG105-07003	48-0985	Fine Filter Element	1
3	KG105-07004	48-0986	Rough Filter Element	1
4	KG105-07001		Air Filter Cover	1
5	KG105-07002		Fastening Screw	1